

COMPANY PROFILE

ALMORI SWIMMING

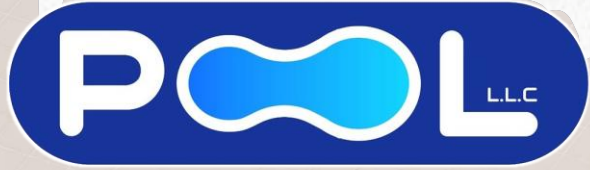

المورين لبحوض السباحة ش.م.م

functional, safety, reliability
and elegance



SHARE OUR PASSION

CONTENTS

Company Profile

- A. Introduction
- B. Product Profile
- C. Team
- D. Completed Projects
- E. Under work Projects
- F. Fountains & waterfalls
- G. Landscaping & Lakes
- H. Contact



BRINGING POOLS TO LIFE

Almori-pools bring pools to life through innovation in design and technical leadership, setting the standard in modern swimming pools.

Our pools combine four elements: function, safety, reliability and elegance. Together with real value-for-money.

Almori-pools meet the needs of both individual homeowners and developers with multiple pool requirements.

For best-of-class swimming pools and professional, straightforward service, contact Almori-pools.

WELCOME TO ALMORI-POOLS

Almori-pools are a leading provider of pools and water features.

We have a strong Retail business installing and servicing private pools for home owners in our local market in Dubai and this is where our story began.

Our core competency today is providing multiple pools for Real Estate and Resort developments, with both the products and the necessary Project Management experience to deliver on- time, on-budget, on-quality.

Through having all skill sets in-house: design, engineering, production, installation and service we are able to ensure professional delivery and performance.

We have become a world-class supplier of specialist pools for exacting requirements such as in the Spa and Wellness and we carry out the design and build of water features.



PRODUCT PROFILE

EXPERIENCES

This document provides data on our Organisation, our Approach, and our Experience.

INCLUDING

maintenance, inspection, and periodic and comprehensive repair of swimming pools providing water treatment services to ensure the highest degree of protection.

WE ARE
EXPERIENCE IN
CREATING AND
MAINTAIN ALL
OF

public-private
hotels&Building
swimming pools

sports and
health clubs
swimming pools

Olympic
swimming pools

Home and kids
swimming pools

Landscaping-
Lakes-Fountains

Jacuzzi Spa Pool

DUBAI COMMERCIAL LICENSE(UAE)



License Activities / نشاطات الرخصة التجارية					
Swimming Pools Maintenance	صيانة أحواض السباحة				
Swimming Pools Installation	تركيب أحواض السباحة				
Address / العنوان					
Phone No	971-04-2858223	تليفون	P.O. Box	10631	صندوق بريد
Fax No	971-04-2858223	فاكس	Parcel ID	215-389	رقم القطعة
Mobile No	971-50-7699514	هاتف متحرك	ملك ابراهيم سعيد احمد لوتاه - ام الرمول-off220 مكتب رقم		
ALMORIPOLS@GMAIL.COM Email / البريد الإلكتروني					
Remarks / الملاحظات					

Print Date 09/11/2020 12:41 تاريخ الطباعة Receipt No. 0 رقم الإيصال

يمكنك الآن تجديد رخصتك التجارية من خلال الرسائل النصية القصيرة، أرسل رقم الرخصة إلى 6969 (دو/اتصالات) للحصول على اذن الدفع.
Now you can renew your trade license by sending a text message (SMS). Send your trade license number to 6969 (Du/ Etisalat) to receive payment voucher.

وثيقة إلكترونية معتمدة وصادرة بدون توقيع من دائرة التنمية الاقتصادية لمراجعة صحة البيانات الواردة في الرخصة برجاء زيارة الموقع www.dubaided.gov.ae
Approved electronic document issued without signature by the Department of Economic Development. To verify the license kindly visit www.dubaided.gov.ae



حكومة دبي
GOVERNMENT OF DUBAI

اقتصادية دبي
DUBAI ECONOMY

رخصة تجارية Commercial License

تفاصيل الرخصة / License Details

License No.	913810	رقم الرخصة
Company Name	ALMORI SWIMMING POOL L.L.C	اسم الشركة
Trade Name	ALMORI SWIMMING POOL L.L.C	الإسم التجارى
Legal Type	Limited Liability Company(LLC)	الشكل القانونى
Expiry Date	27/10/2021	تاريخ الإنتهاء
D&B D-U-N-S ®	0	الرقم العالمى
Register No.	1521809	رقم السجل التجارى
Issue Date	28/10/2020	تاريخ الإصدار
Main License No.	913810	رقم الرخصة الام
DCCI No.	347790	عضوية الغرفة

الإطراف / License Members

Share / الحصص	Role / الصفة	Nationality / الجنسية	Name / الإسم	No./ رقم الشخص
	Manager / مدير	Egypt / مصر	نور الدين محمد محمد نور الدين	867609

NOUR ELDDIN MOHAMED MOHAMED
MOHAMED NOURELDIN

CERTIFICATE OF REGISTRATION FOR VALUE ADDED TAX IN (UAE)

First VAT Return Period: 01 Mar 2021 - 31 May 2021 and quarterly thereafter فترة أول إقرار لضريبة القيمة المضافة
VAT Return due date: 28 Jun 2021 تاريخ استحقاق إقرار ضريبة القيمة المضافة
Start and end dates of Tax periods: 1 Mar to 31 May, 1 Jun to 31 Aug, 1 Sep to 30 Nov, 1 Dec to 28/29 Feb بداية ونهاية الفترات الضريبية

يرجى التأكد من صحة تفاصيل الشهادة. يجب إبلاغ الهيئة الاتحادية للضرائب في حال تغيير الاسس التي حصلت فيها على رقم التسجيل الضريبي الخاص بك.

Please check that the details on this certificate are correct. You must inform the Federal Tax Authority of any change on the basis of which you obtained your Tax Registration Number.



Issuing Date: 24/02/2021 تاريخ الإصدار

الهيئة الاتحادية للضرائب
FEDERAL TAX AUTHORITY



شهادة تسجيل لضريبة القيمة المضافة في الامارات العربية المتحدة Certificate of Registration for Value Added Tax in the United Arab Emirates

The Federal Tax Authority certifies that the entity below is a registered person for Value Added Tax in the UAE تشهد الهيئة الاتحادية للضرائب أن الجهة التالية مسجلة لضريبة القيمة المضافة في الامارات العربية المتحدة

Full Arabic legal name: المورين لاجواض السباحة ش. ذ. م. م الاسم القانوني الكامل باللغة العربية
Full English legal name: ALMORI SWIMMING POOL LLC الاسم القانوني الكامل باللغة الانجليزية
Registered address: مكتب رقم OFF220 ملك ابراهيم سعيد احمد لوتاه، ام الرمولى، ام الرمولى، دبي، Dubai، الإمارات العربية المتحدة، 10631، 971507699514+ العنوان المسجل
Tax Registration Number: 100460424300003 رقم التسجيل الضريبي
Effective Registration Date: 01/03/2021 تاريخ التسجيل الفعلي



TEAM

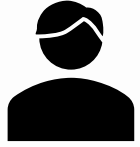

Marwan Al Marzouki

- **The Chairman**



Nour Elden Mohamed

- **Partner**
- **Executive Manager**



Rehab Kamal

- **Accountant**
- **HR**



Ahmed Mohamed

- **IT Support**



Ahmed Sayed

- **Graphic designer**



Hassan Ripoll

- **Electrician and piping technician**



Raheem Miah

- **Electrician and piping technician**



Asif Khan

- **Electrician and piping technician**



Mohamed Rebon

- **Ceramic installation**



Shaheen Ali

- **Ceramic installation**



Mueayan Aldiyn

- **Ceramic installation**



Abdul Malik Miah

- **Steel fixers**



Menon Ali

- **Steel fixers**



Mohamed Rabiol

- **Steel fixers**



المورين لاجواض السباحة



PREFORMED COMPOSITE POOL SHELL STRUCTURE

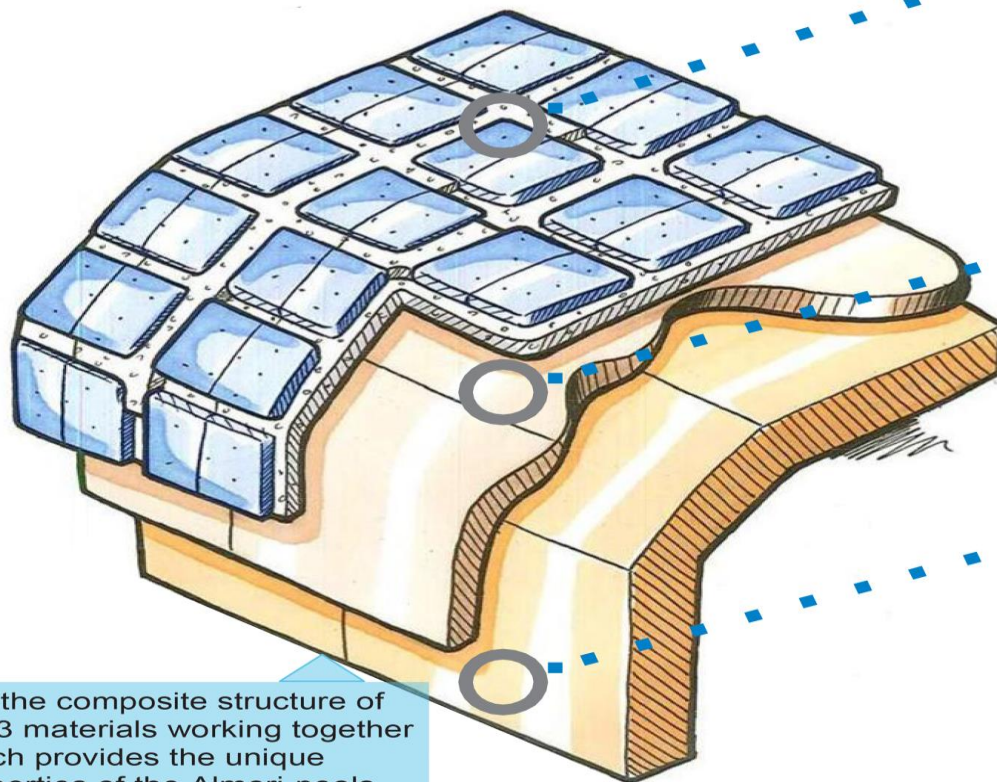

PORCELAIN CERAMIC MOSAIC TILE:

The internal finish is a hand applied mosaic tile finish, using epoxy grout to maximize in-use service life as well as providing the choice of a wide range of colours and styles.

EPOXY LAMINATE:

The inner layer is a 2 part, reactive epoxy system. This proprietary system cures to form an Epoxy laminate which completely prevents exposure of the GRP to pool water and associated chemicals.

GRP (Glass Reinforced Plastic):

The GRP outer body consists of spray applied, high performance resins reinforced with woven glass fibres.

It is the composite structure of the 3 materials working together which provides the unique properties of the Almori-pools Pre-formed pool shell.

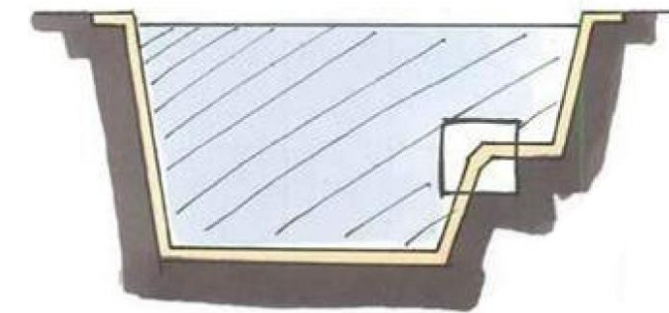

COMPLETED PROJECTS

Project: Proposed Swimming Pool

Private Villa

 Client : Alsayed Aref

 Private Villa

 location : Al Barsha 3- Dubai

 Length: 15.00 * Width: 6.00

 Depth : 1.40 One level

 Pool Overflow

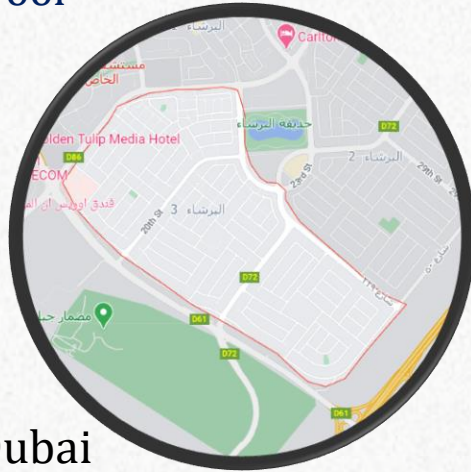

COMPLETED PROJECTS

Project: Proposed Swimming Pool

Private Villa

 Client : Sheikh Ahmed

 Private Villa

 location : Sharjah Al khan

 Length: 9.00 * Width: 5.00

 Depth : 0.90 To 1.80

 Pool Overflow

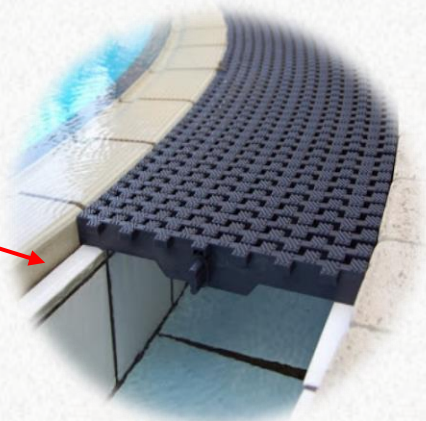
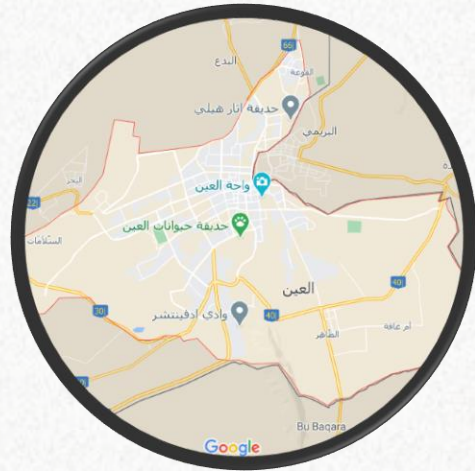

المورين لاجواض السباحة

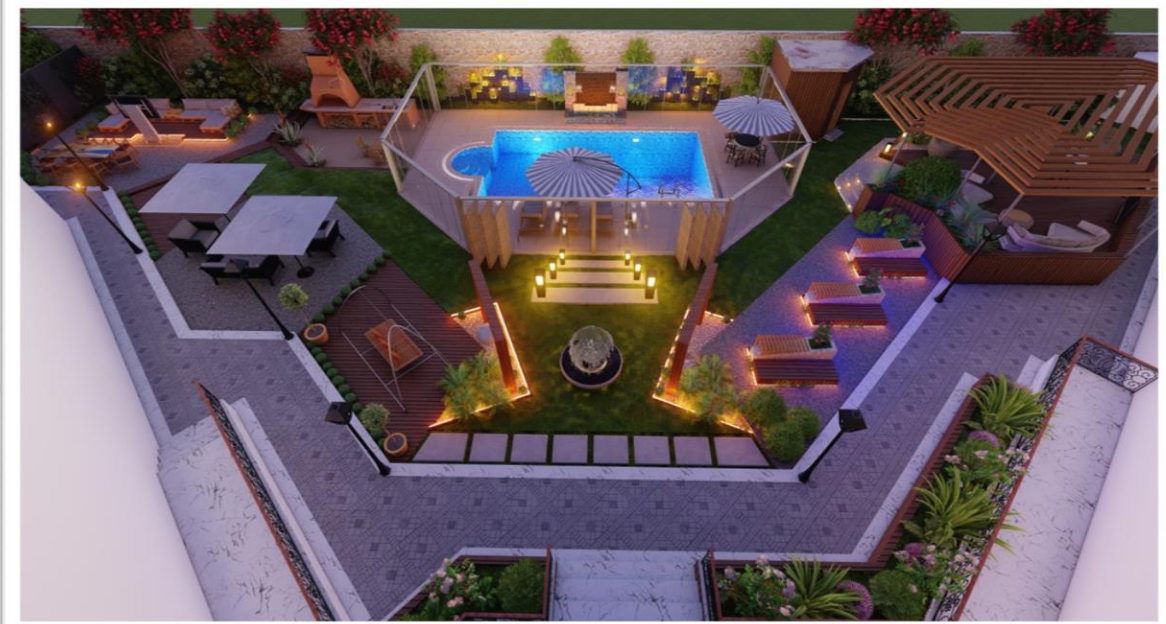

COMPLETED PROJECTS

Project: Proposed Swimming Pool

Private Villa

 Client :Mr. Abdullah

 Private Villa

 location : Dubai Al Khawaneej

 Length:18.00 * Width:7.00

 Depth :0.80 To 1.60

 Pool Overflow



المورين لاجواض السباحة

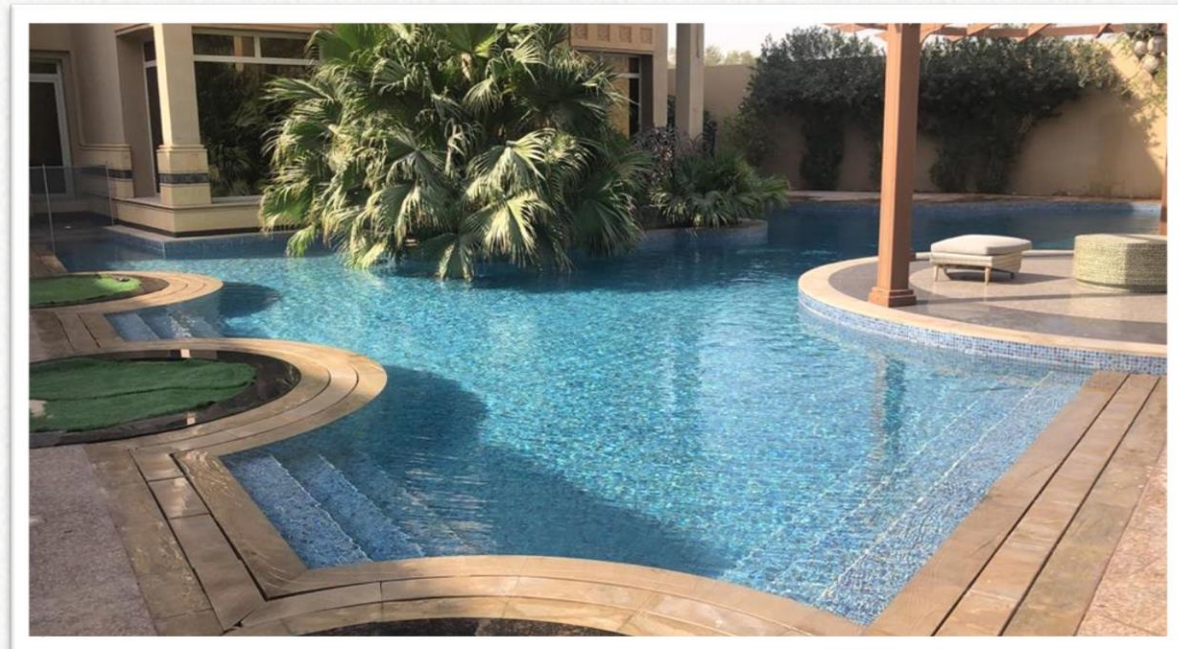
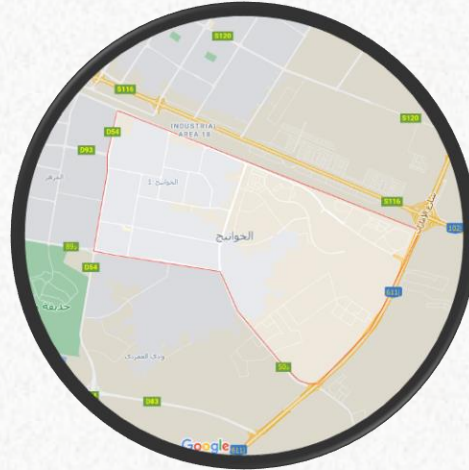

COMPLETED PROJECTS

Project: Proposed swimming pools

Public Building

 Client : Al Rand Building

 Building

 location : Sharjah Al Khan

 Length: 18.00 * Width: 7.00

 Depth 0.50 To 1.70

 Pool Overflow

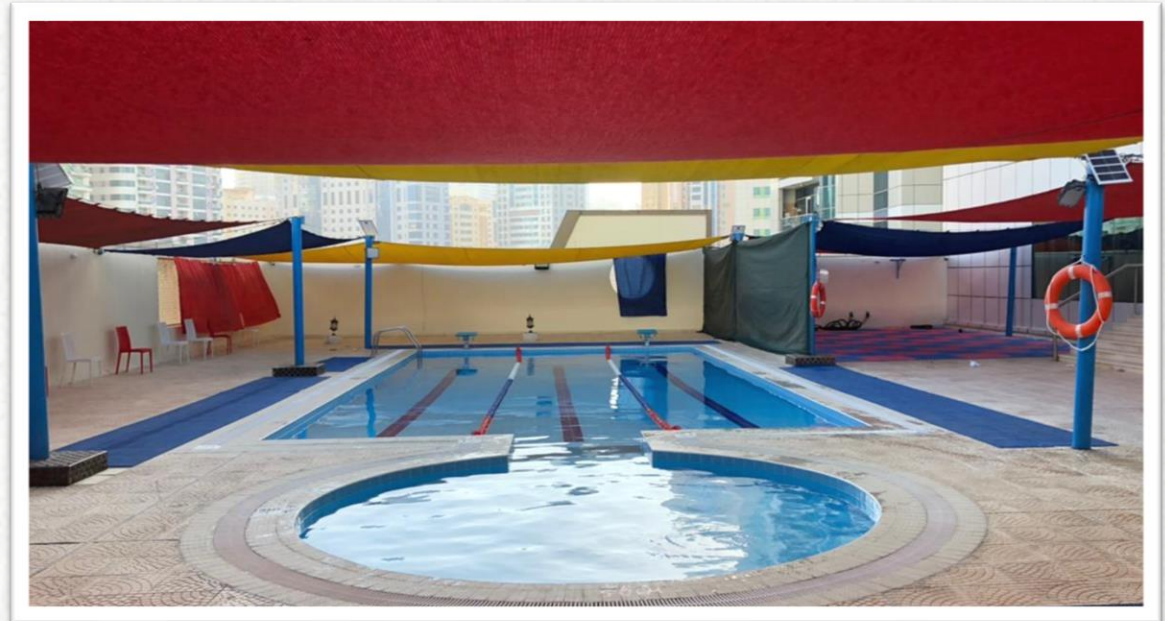
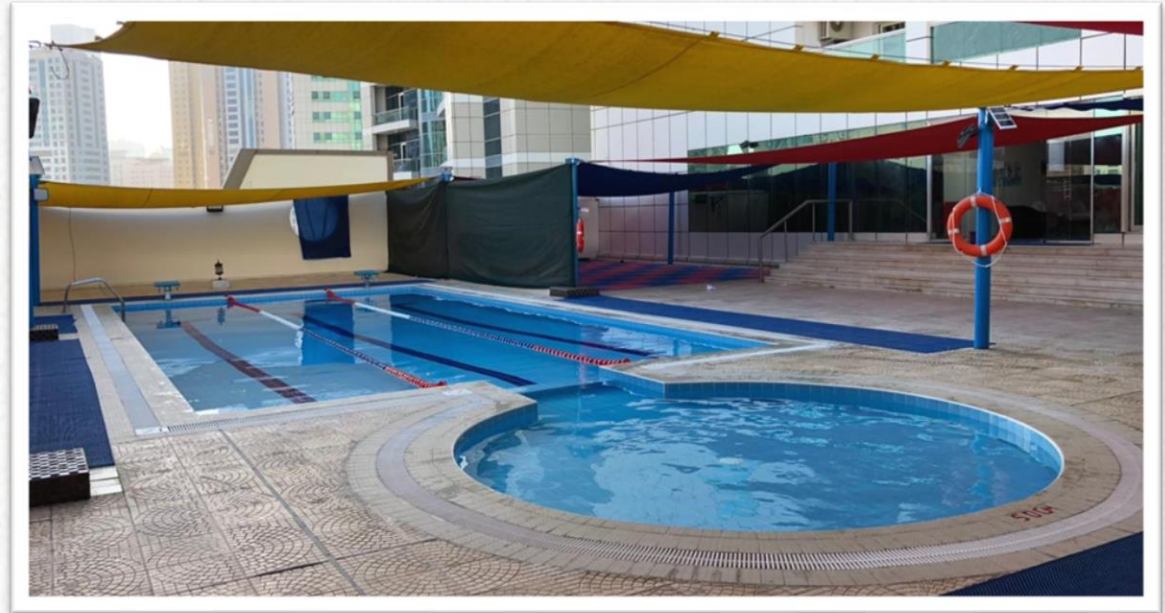



المورين لاجواض السباحة

COMPLETED PROJECTS

Project: Proposed swimming pools

Public Building

 Client :Jamal Jawhar

 Al Jawhar Towers A&B

 location : Sharjah Al khan

 Length:12.00 * Width:6.00

 Depth :1.00 To 1.70

 Pool Skimmer

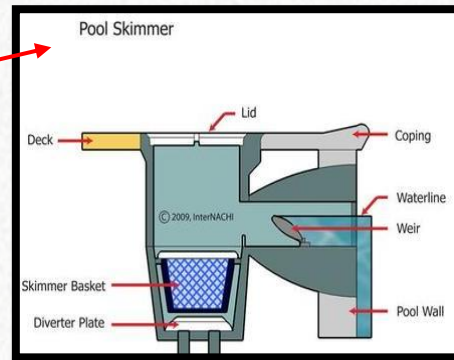
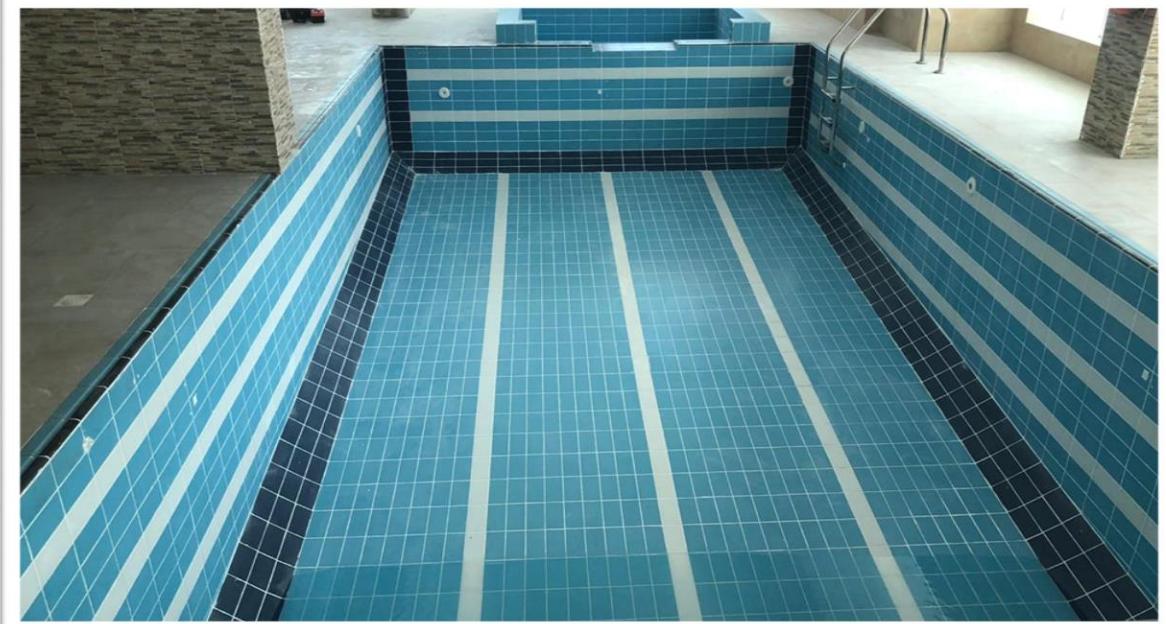
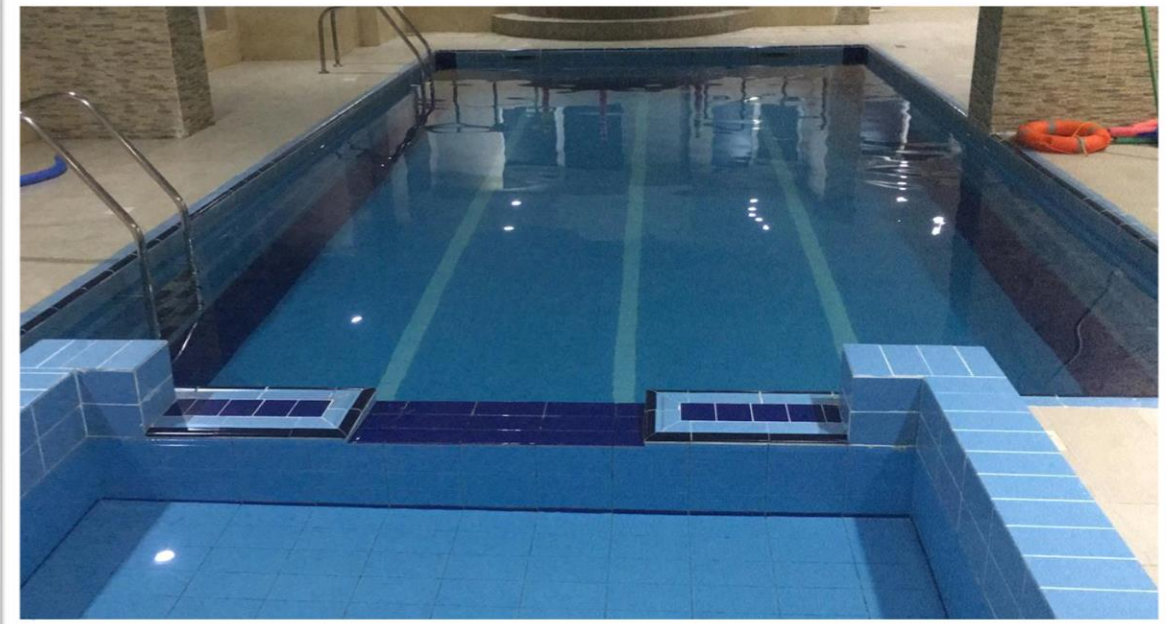
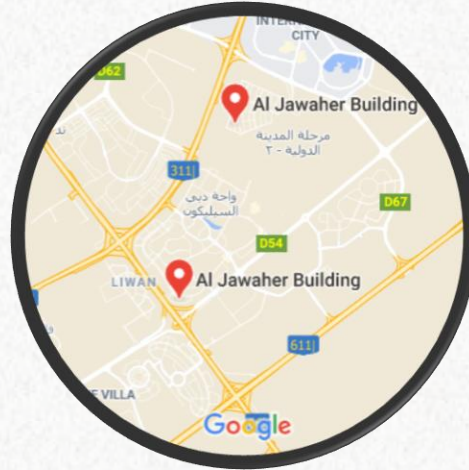

المورين لاجواض السباحة

COMPLETED PROJECTS

Project: Proposed Olympic

swimming pools

 Client :Palm Tower

 Tower

 location : sharjah Al khan

 Length:25.00 * Width:15.00

 Depth :1.00 To 1.70

 Pool Overflow



المورين لاجواض السباحة للش.م.م



COMPLETED PROJECTS

Project: Proposed swimming pools

Public Building

 Client : Al Saada Tower

 Tower

 location : Sharjah Al Khan

 Length: 15.00 * Width: 5.00

 Depth : 1.00 To 1.60

 Pool Overflow



المورين لاجواض السباحة

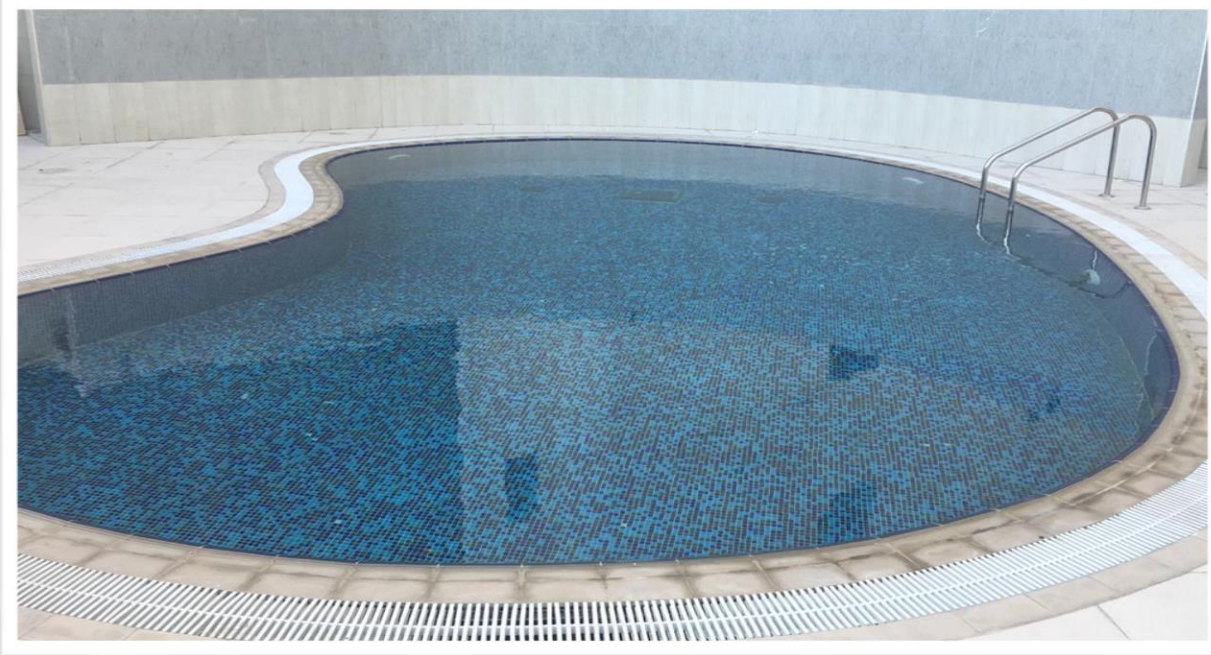
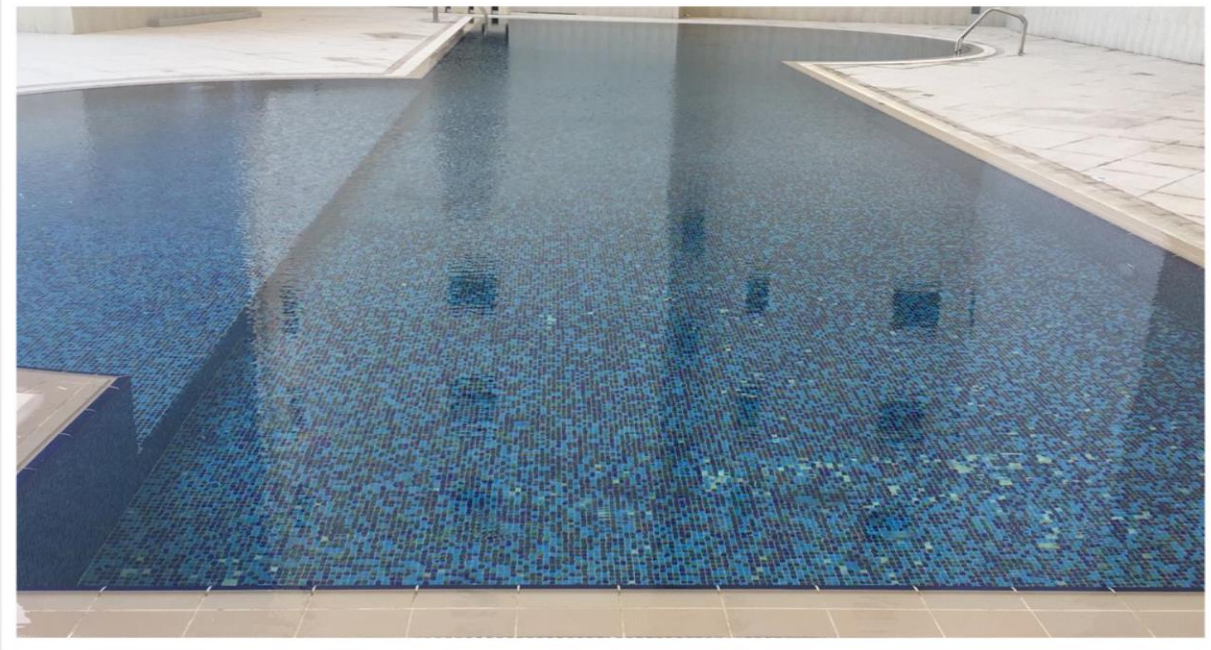
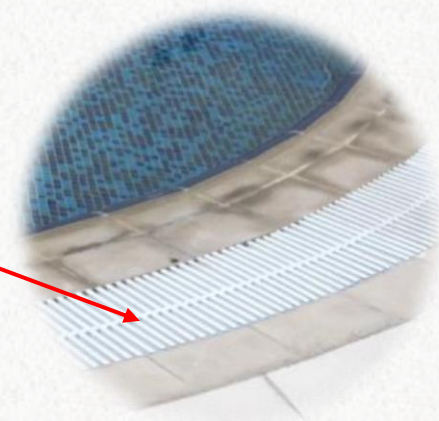

COMPLETED PROJECTS

Project: Proposed Swimming Pool

Private Villa

 Client : Fares Al Hosani

 Private Villa

 location : Ajman , Al Helio

 Length: 7.00 * Width: 3.00

 Depth : 0.80 To 1.60

 Pool Skimmer

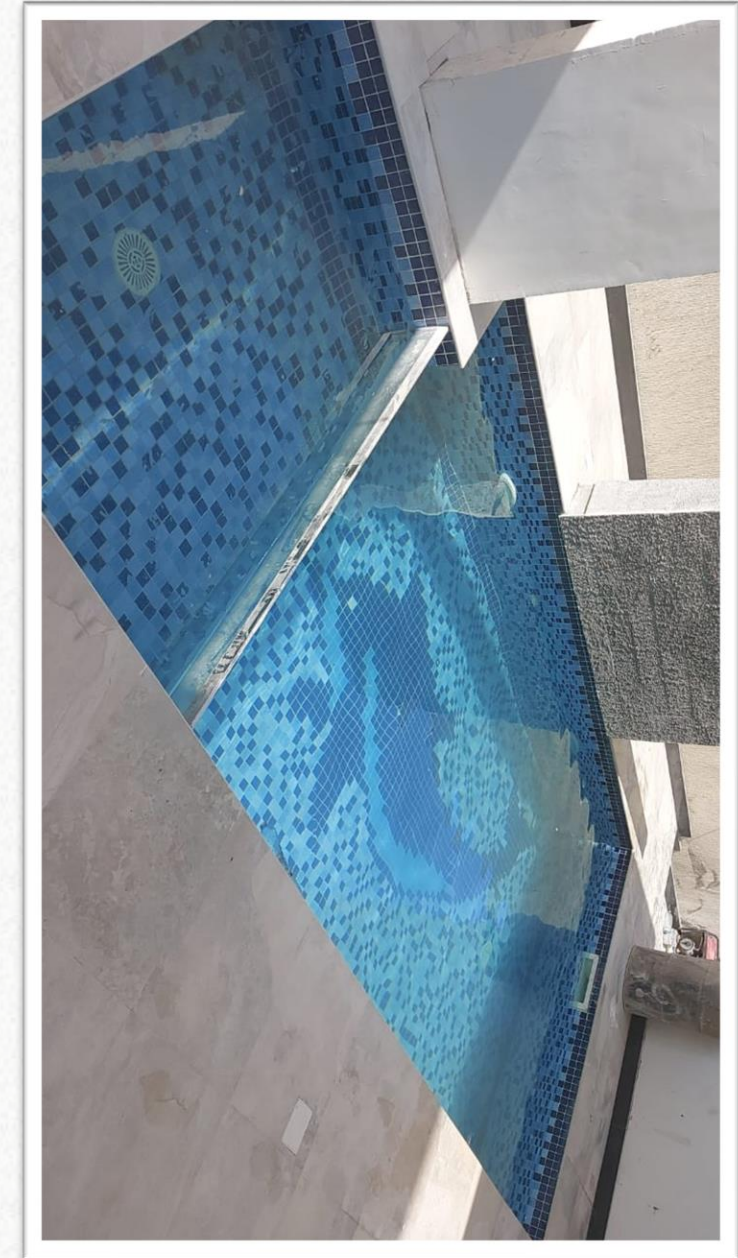
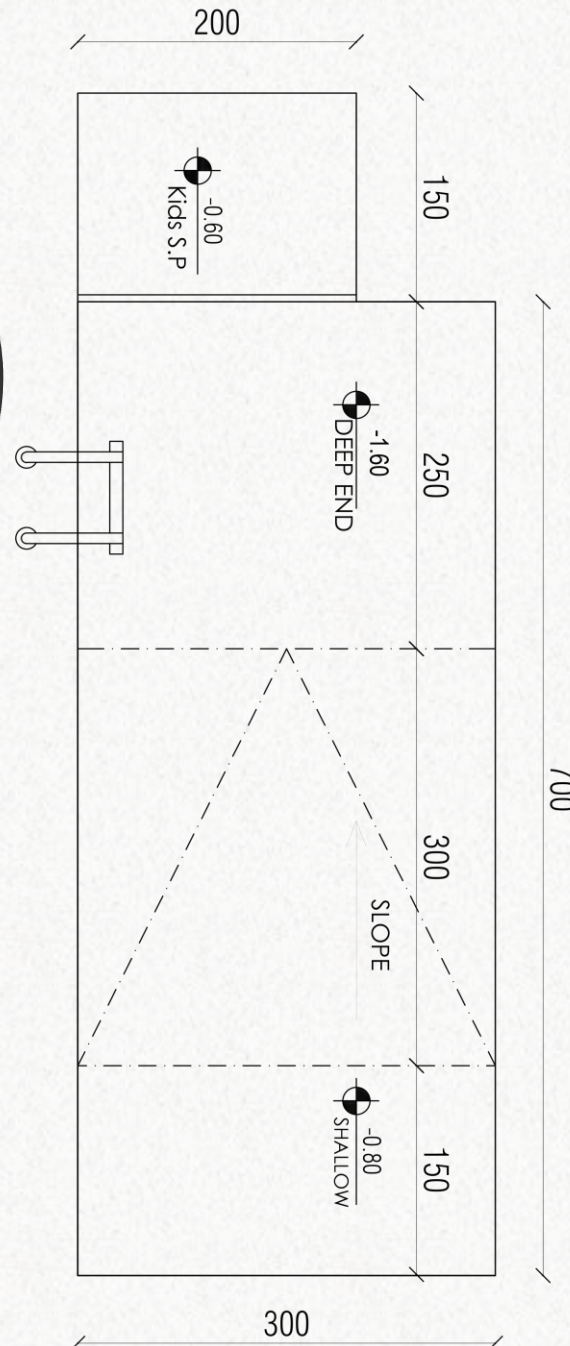
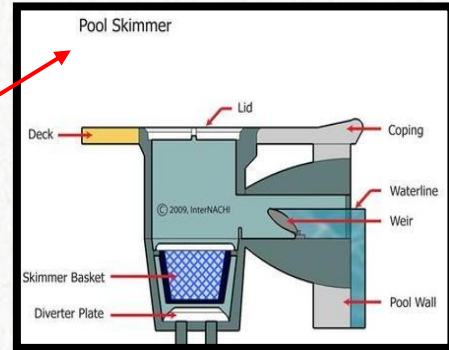
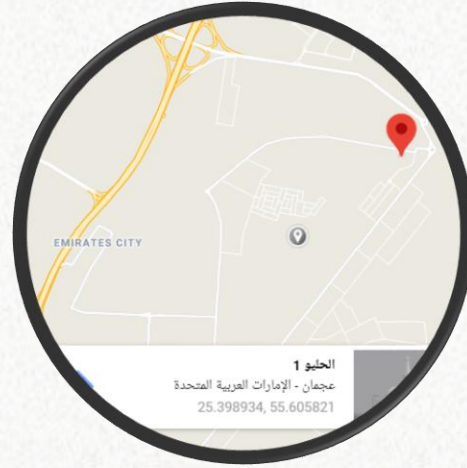



COMPLETED PROJECTS

Project: Proposed Public swimming pools

 Client :M.Al Zubair

 Tower

 location : Sharjah Al khan

 Length:25.00 * Width:10.00

 Depth :1.00 To 1.90

 Pool Skimmer

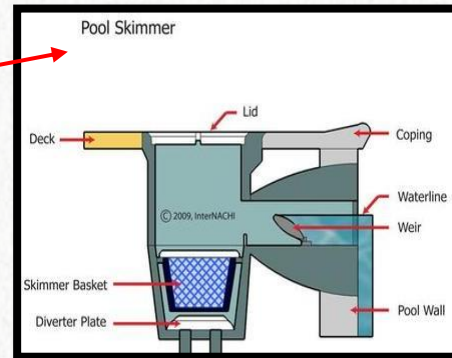

المورين لاجواض السباحة

COMPLETED PROJECTS

Project: Proposed swimming pools

Public Building

 Client :Amanda Tower A&B

 Tower

 location : Sharjah Al khan

 Length:10.00 * Width:3.50

 Depth :1.50 One level

 Pool Overflow



المورين لاجواض السباحة

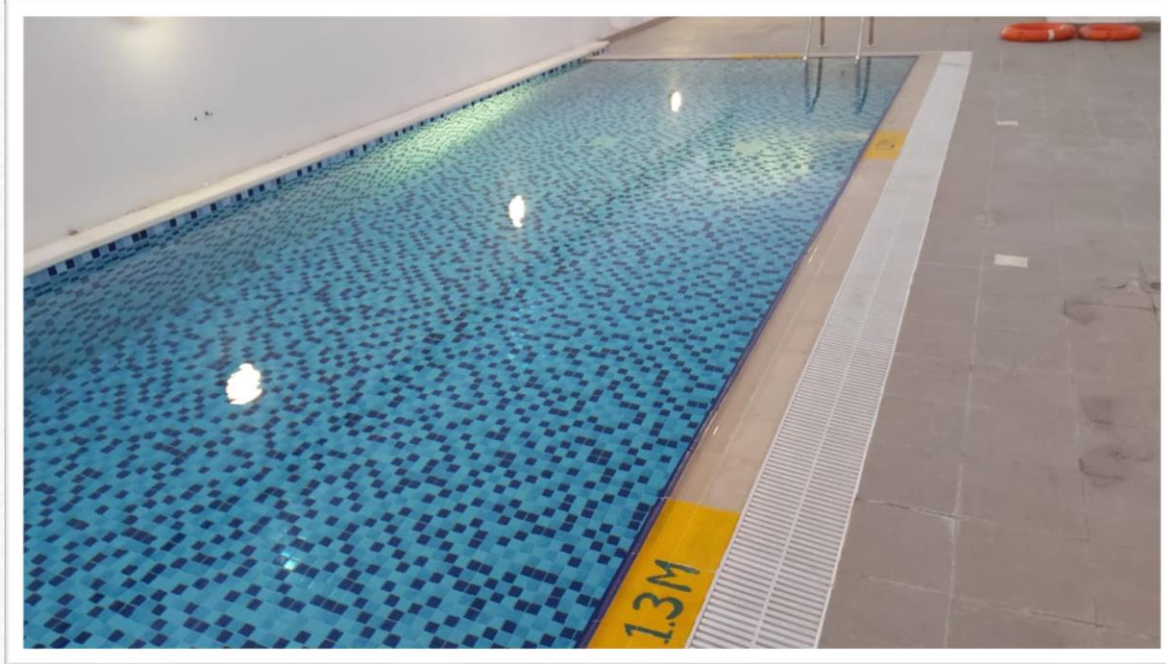
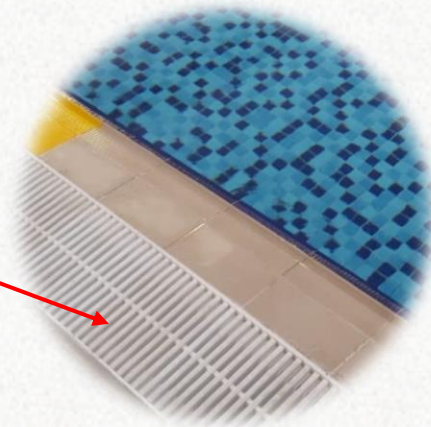

UNDER WORK PROJECTS

Project: Proposed Swimming Pool

Private Villa

 Client : M.Hamd

 Private Villa

 location : Jumeirah,Al Safa- Dubai

 Length:1.00 * Width:5.00

 Depth :1.00 To 1.60

 Pool Overflow



Jacuzzi



UNDER WORK PROJECTS

Project: Proposed Swimming Pool

Private Villa

Client : M. Jamal

Private Villa No.11

location : Jumeirah Islands , Cluster 45

Length:7.00 * Width:3.00

Depth :1.00 To 1.60

Pool Overflow



المورين لاجواض السباحة

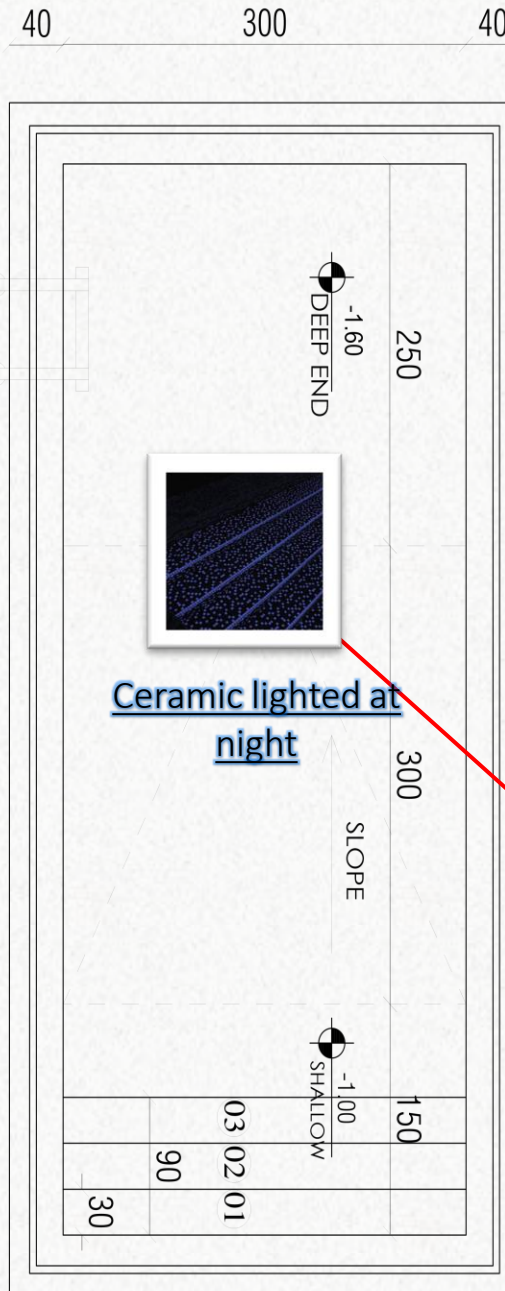
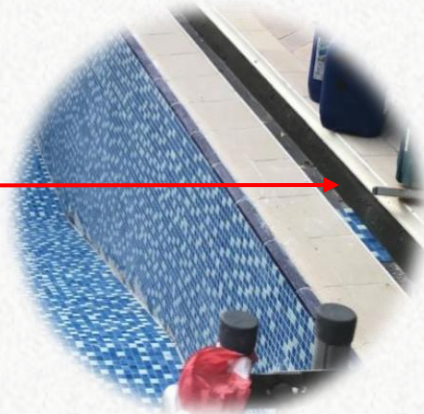

UNDER WORK PROJECTS

Project: Proposed Swimming Pool

Private Villa

 Client :Ahmed Al Wars

 Private Villa

 location : Ajman , Al Jurf 2

 Length:7.40 * Width:6.65

 Depth :0.80 To 1.40

 Pool Overflow

ALMORI SWIMMING

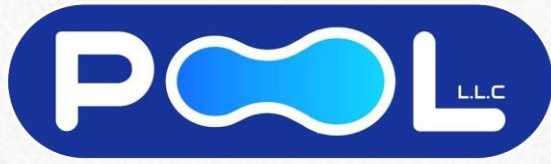

المورين لاجواض السباحة

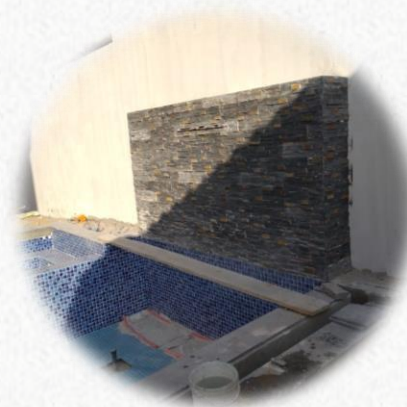
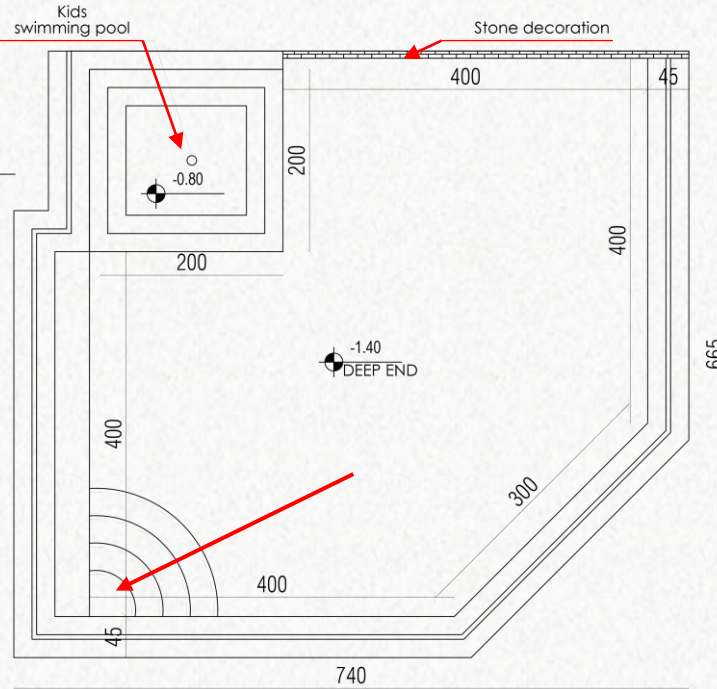

Waterfall

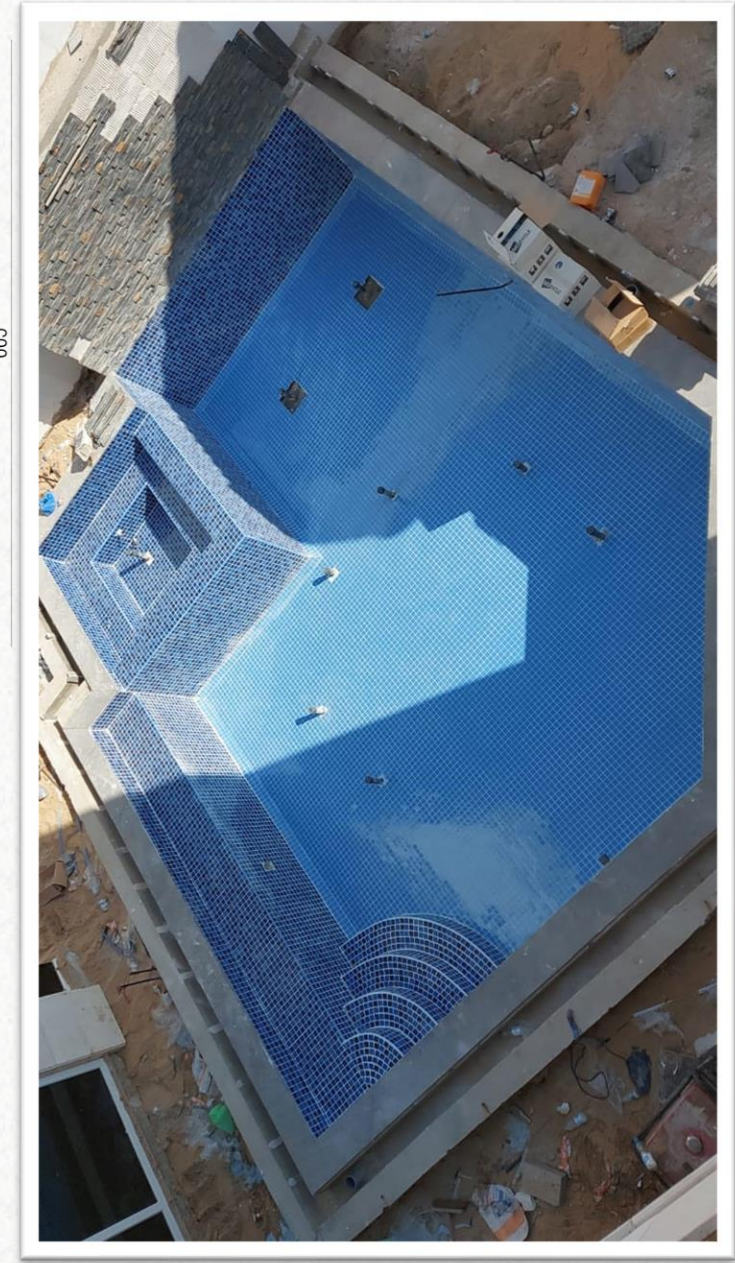

UNDER WORK PROJECTS

Project: Proposed Swimming Pool

Private Villa

 Client : Khaled Al Balushi

 Private Villa

 location : Al Suyoh 6 - Sharjah

 Length:9.00 * Width:5.00

 Depth :1.50 One level

 Pool Overflow



المورين لادواض السباحة

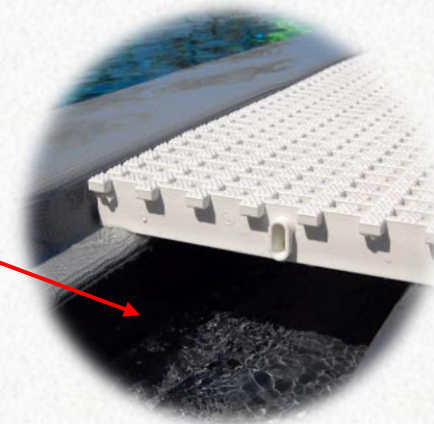

FOUNTAINS AND WATERFALLS

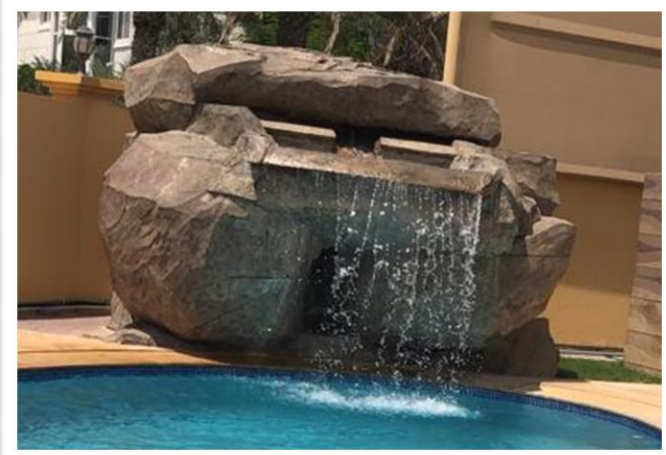
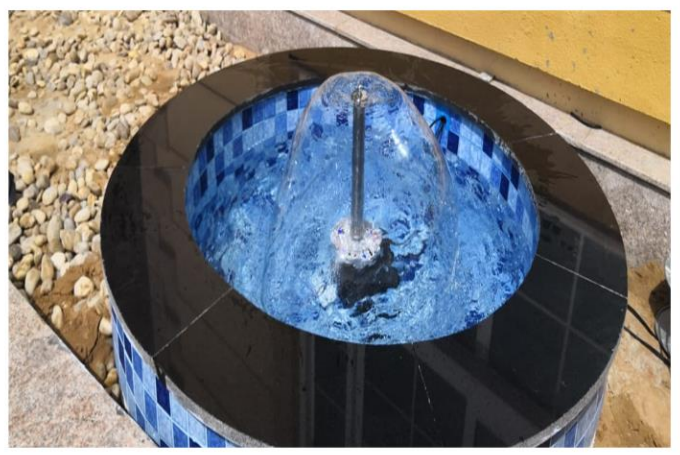
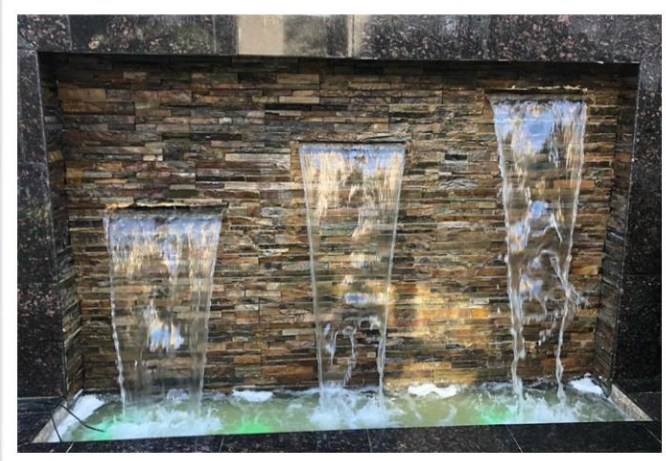

المورين لاجواض السباحة

FOUNTAINS AND WATERFALLS

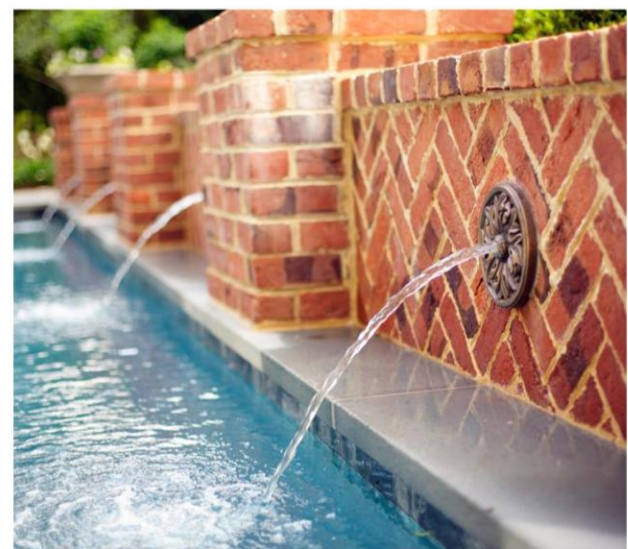
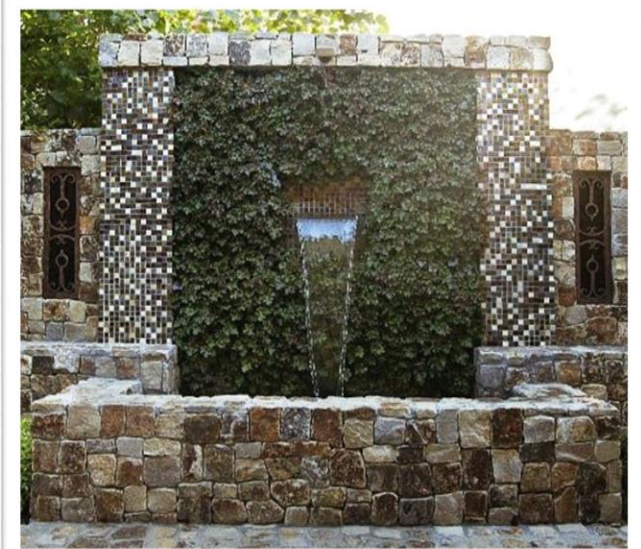
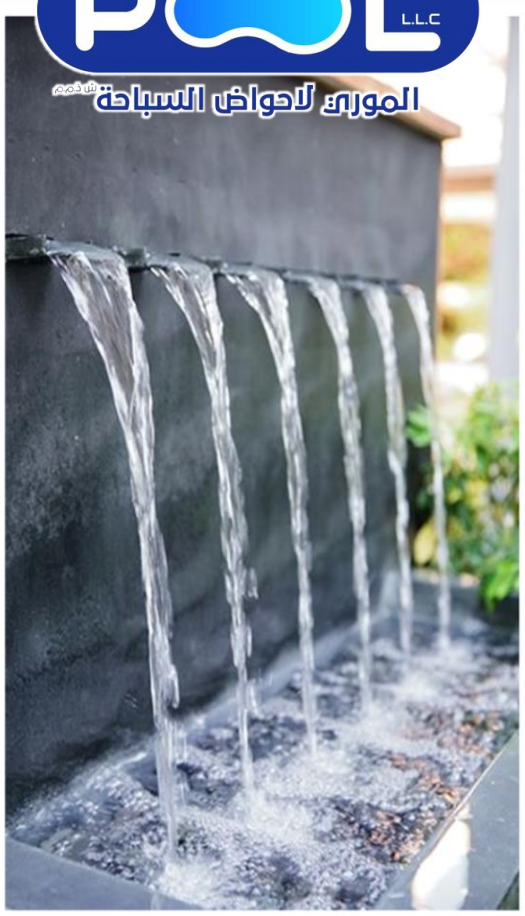

SWIMMING POOL FOUNTAINS

ALMORI SWIMMING

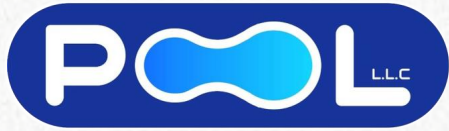

المورني لاجواض السباحة



CLASSIC FOUNTAINS



المورني للافواض السباحة



MODERN FOUNTAINS

ALMORI SWIMMING

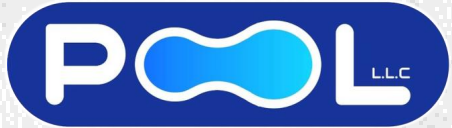

المورني لبحوض السباحة



LANDSCAPING



المورين لاجواض السباحة

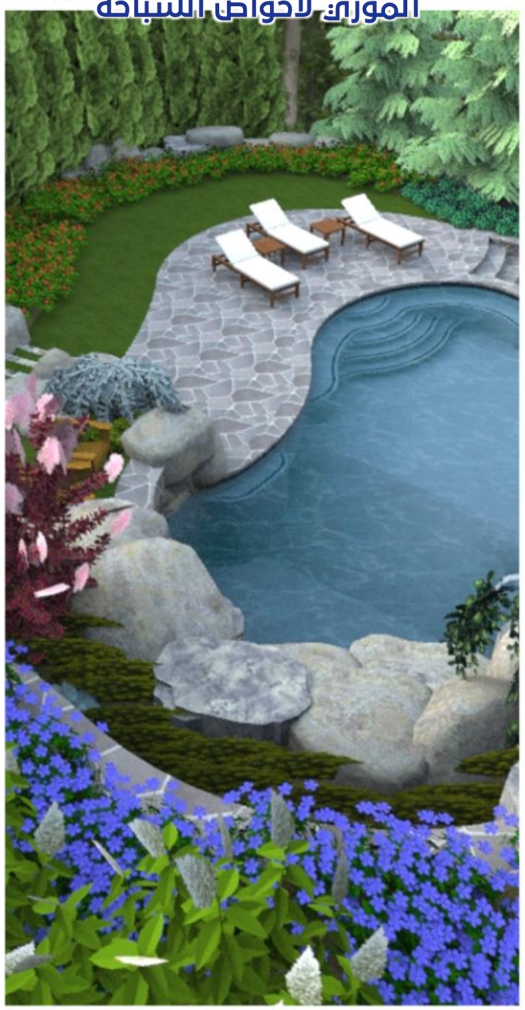



LAKES



المورين لاجواض السباحة ش.ذ.م.م

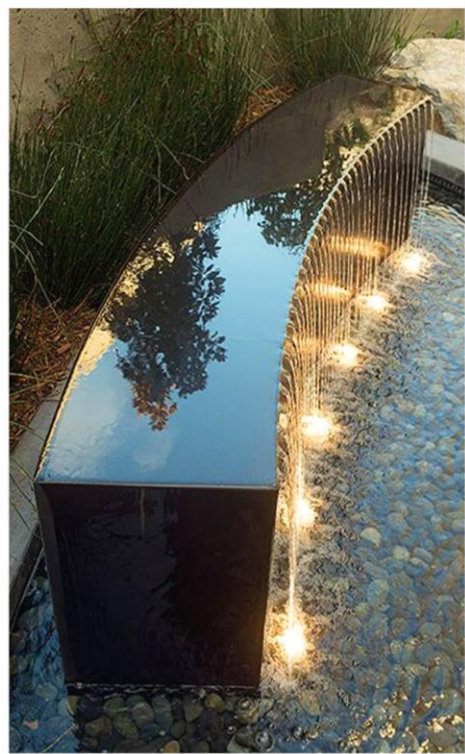
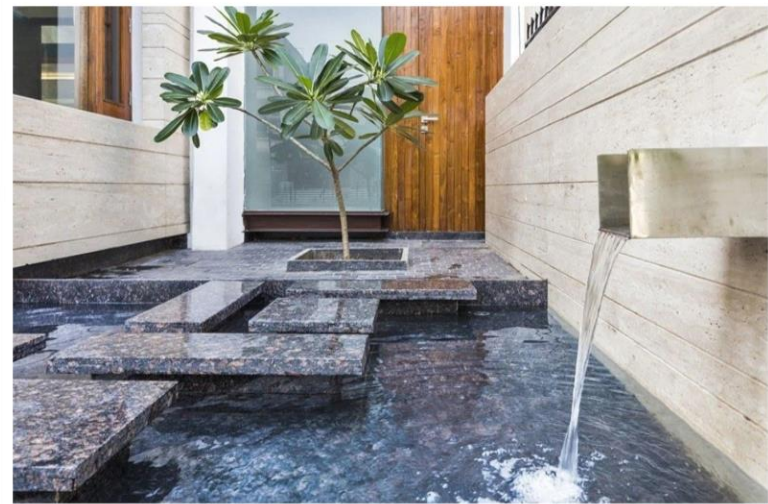





CONTACT

WWW.ALMORIPOOLS.COM

 NOUR ELDIN MOHAMED

 +971-507699514

 +971042858223

 almoripools@gmail.com

 Instagram: almoripools

 P.O.Box: 10631, Dubai, UAE